

7050 COMFORT SİSTEM

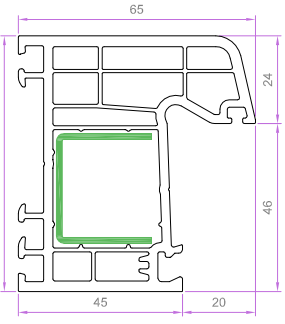

KASA PRF. (5-ODACIKLI)
7151 1.382 kg/m
7151 EU-B 1.245 kg/m

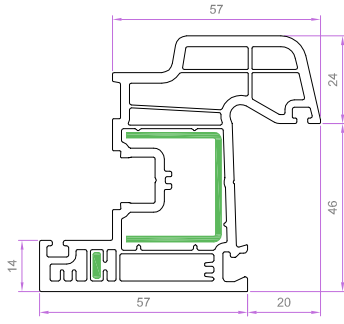

KANAT PROFİLİ (5-ODACIKLI)
7152 1.458 kg/m
7152 EU-B 1.300 kg/m

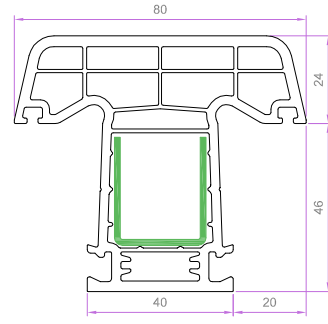

ORTA KAYIT PRF. (5-ODACIKLI)
7153 1.491 kg/m
7153 EU-B 1341 kg/m

6040 DIAMOND SİSTEM PROFİLLERİ

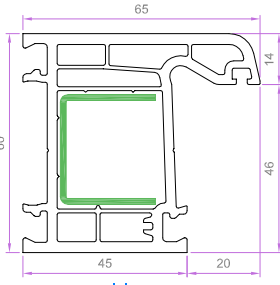

KASA PROFİLİ
6041 1.243 kg/m
6041 EU-B 1.032 kg/m

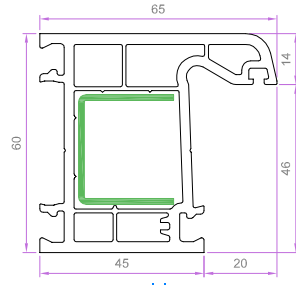

KASA PROFİLİ
6031 1.210 kg/m
6031 EU-B 1.004 kg/m

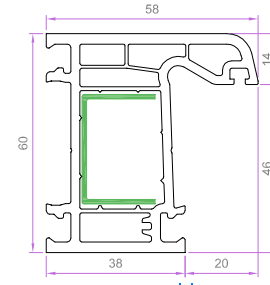

DAR KASA PROFİLİ
6141 1.099 kg/m
6141 EU-B 0.974 kg/m

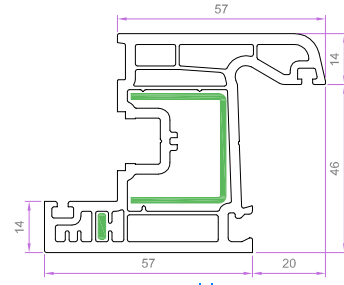

KANAT PROFİLİ
6042 1.403 kg/m
6042 EU-B 1.156 kg/m

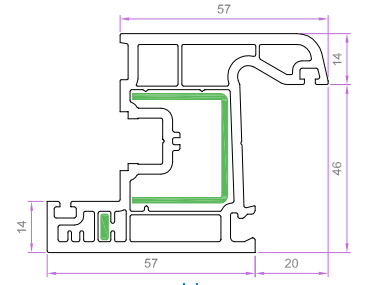

KANAT PROFİLİ
6032 1.374 kg/m
6032 EU-B 1.224 kg/m

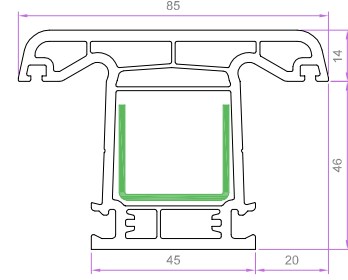

ORTA KAYIT PROFİLİ
6043 1.433 kg/m
6043 EU-B 1.187 kg/m

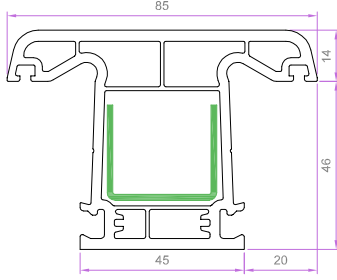

ORTA KAYIT PROFİLİ
6033 1.396 kg/m
6033 EU-B 1.236 kg/m

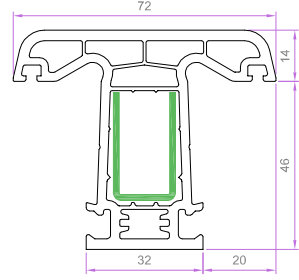

DAR ORTA KAYIT PRF.
6143 1.194 kg/m
6143 EU-B 1.051 kg/m

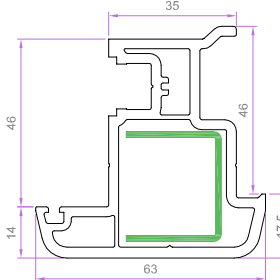

HAREKETLİ ORTA KAYIT PROFİLİ
6044 1.078 kg/m

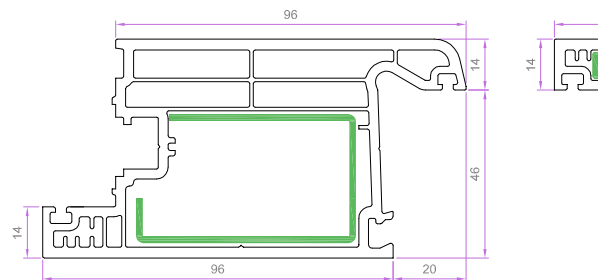

KAPI KANAT PROFİLİ 'İÇERİ AÇILAN'
6045 1.834 kg/m

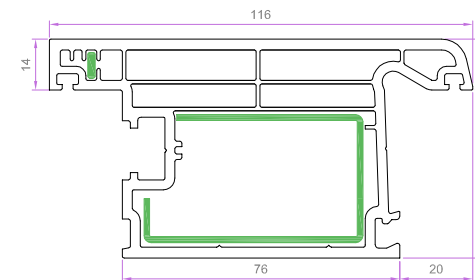

KAPI KANAT PROFİLİ 'DIŞARI AÇILAN'
6048 1.832 kg/m

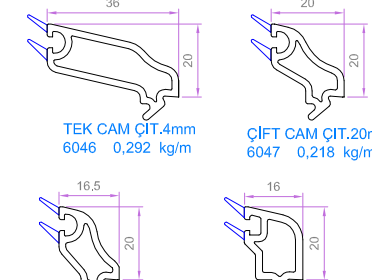

TEK CAM ÇİT.4mm
6046 0.292 kg/m

ÇİFT CAM ÇİT.20mm
6047 0.218 kg/m

ÇİFT CAM ÇİT.24mm
6049 0.204 kg/m

OVAL ÇİFT CAM ÇİT.24mm
6058 0.228 kg/m

6022 HAYAT VE ALTERNATİF HAYAT SİSTEM PROFİLLERİ

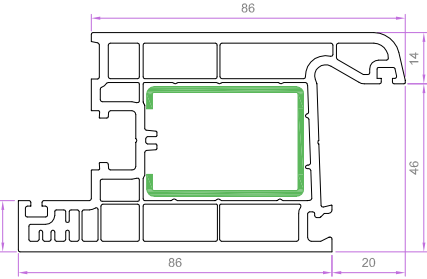

YENİ KAPI KANAT PRF. (İÇERİ AÇILAN)
6145 1.728 kg/m
6145 EU-B 1.511 kg/m

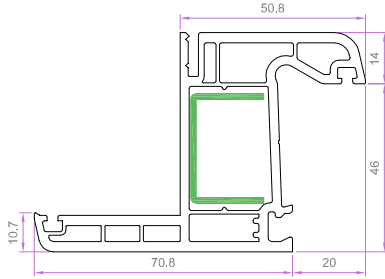

PERVAZLI KASA PROFİLİ
6054 1.295 kg/m

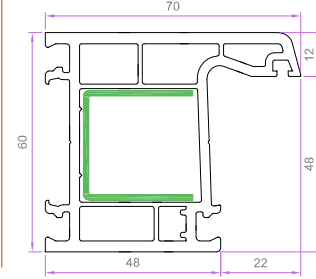

HAYAT KASA PROFİLİ
6022 1.279 kg/m
6024 EU-B 1.167 kg/m

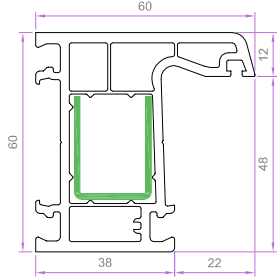

HAYAT EKO KASA
6232 1.062 kg/m
6234 EU-B 0.965 kg/m

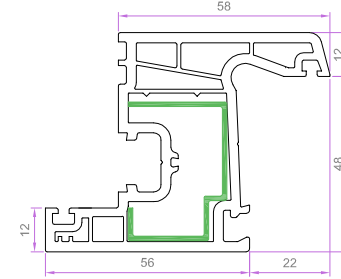

HAYAT KANAT PROFİLİ
6027 1.332 kg/m
6028 EU-B 1.232 kg/m

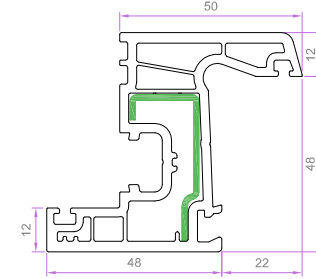

HAYAT EKONOMİK KANAT
6240 1.199 kg/m
6236 EU-B 1.055 kg/m

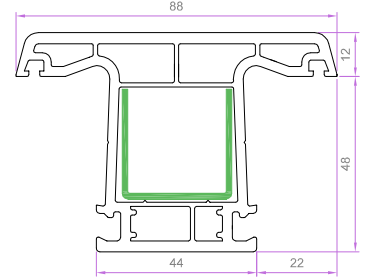

HAYAT ORTA KAYIT PROFİLİ
6023 1.411 kg/m
6025 EU-B 1.281 kg/m

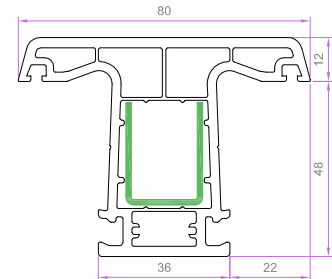

HAYAT EKO O.KAYIT PRF.
6233 1.215 kg/m
6235 EU-B 1.107 kg/m

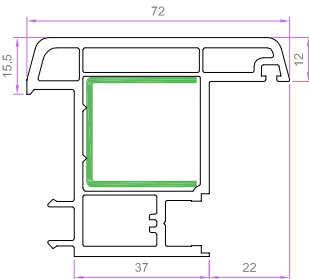

HAREKETLİ O.KAYIT PROFİLİ
6029 1.117 kg/m

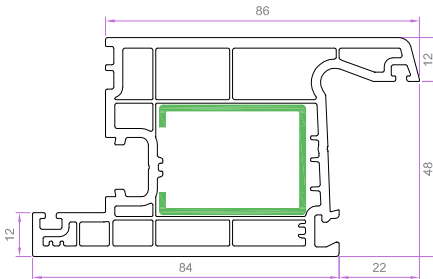

HAYAT KAPI KANAT PRF. (İÇERİ AÇILAN)
6241 1.892 kg/m
6237 EU-B 1.511 kg/m

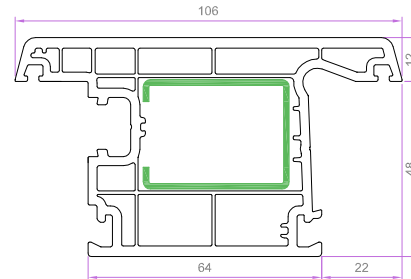

HAYAT KAPI KANAT PRF. (DIŞARI AÇILAN)
6242 1.695 kg/m
6238 EU-B 1.517 kg/m

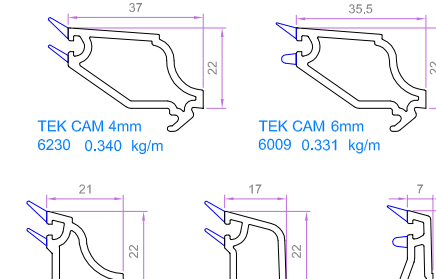

TEK CAM 4mm
6230 0.340 kg/m

TEK CAM 6mm
6009 0.331 kg/m

ÇİFT CAM 20mm
6231 0.256 kg/m

ÇİFT CAM 24 mm
6239 0.229 kg/m

ÜÇ CAM 34mm
6011 0.198 kg/m

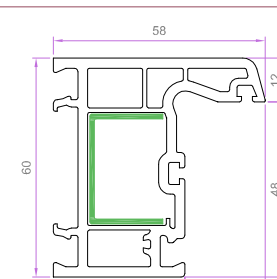

EKO KASA PROFİLİ
6001 1.136 kg/m

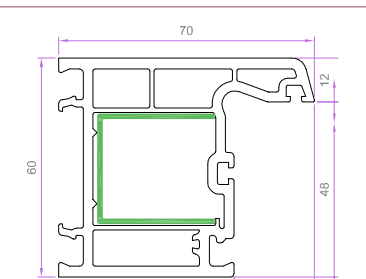

SÜPER KASA PROFİLİ
6002 1.304 kg/m

6000 SÜPER SİSTEM PROFİLLERİ

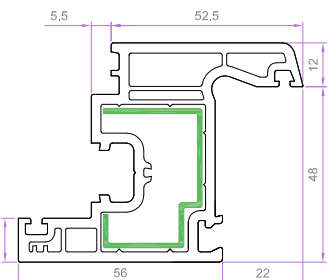

NORMAL KANAT PROFİLİ
6003 1.330 kg/m

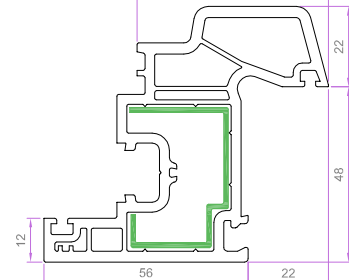

DAMLALIKLI KANAT PROFİLİ
6004 1.434 kg/m

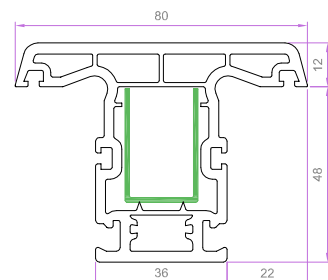

ORTA KAYIT PROFİLİ
6005 1.391 kg/m

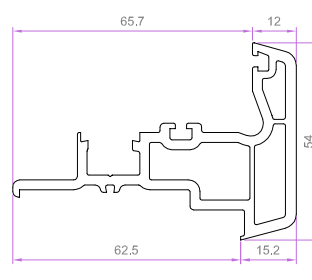

HAREKETLİ ORTA KAYIT PROFİLİ
6006 0.985 kg/m

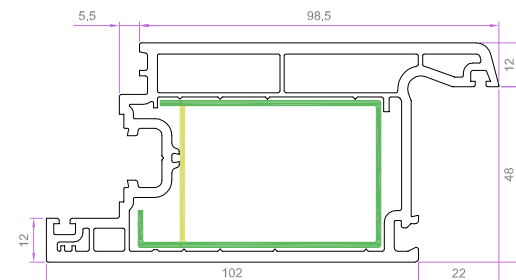

KAPI KANAT PROFİLİ 'İÇERİ AÇILAN'
6007 1.821 kg/m

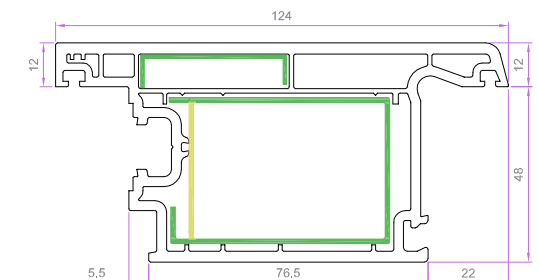

KAPI KANAT PROFİLİ 'DIŞARI AÇILAN'
6008 1.834 kg/m

5200 SİSTEM PROFİLLERİ

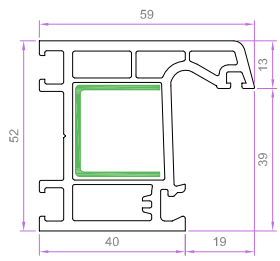

KASA PROFİLİ
5201 1.018 kg/m
5201 EU-B 0.901 kg/m

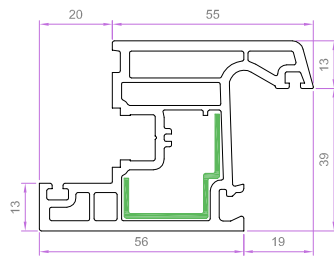

KANAT PROFİLİ
5202 1.192 kg/m
5202 EU-B 1.049 kg/m

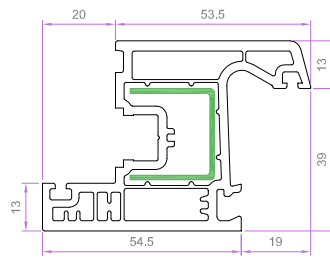

YENİ KANAT PROFİLİ
5212 1.170 kg/m
5212 EU-B 1.059 kg/m

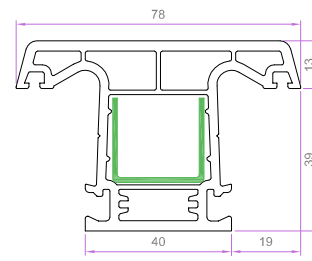

ORTA KAYIT PRF.
5203 1.197 kg/m
5203 EU-B 1.076 kg/m

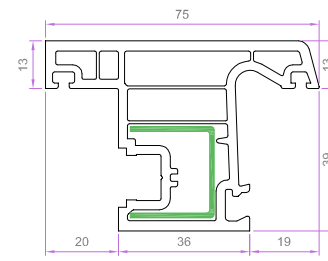

DIŞARI AÇILAN PENCERE KANAT
5209 1.177 kg/m

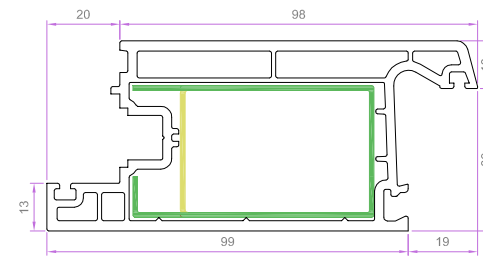

KAPI KANAT PROFİLİ
5204 1.616 kg/m

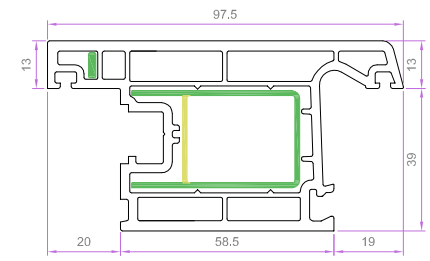

DIŞARI AÇILAN KAPI KANAT PROFİLİ
5210 1.502 kg/m

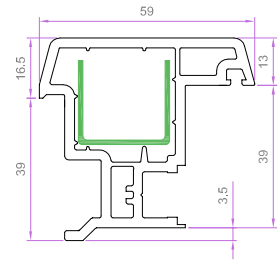

H. ORTA KAYIT PROFİLİ
5207 0.940 kg/m

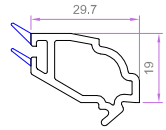

TEKCAM ÇİTASI
5211 0.292 kg/m

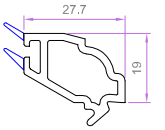

TEKCAM ÇİTASI
5205 0.281 kg/m

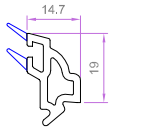

ÇİFTCAM ÇİTASI
5206 0.208 kg/m

7400 SÜRME SİSTEM PROFİLLERİ

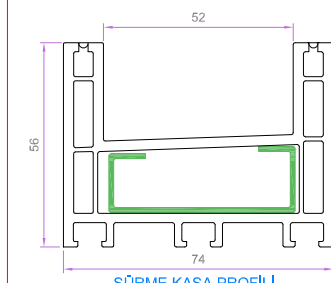

SÜRME KASA PROFİLİ
7401 1.373 kg/m

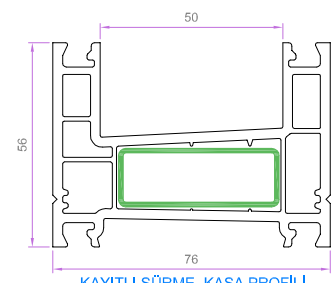

KAYITLI SÜRME KASA PROFİLİ
7406 1.361 kg/m

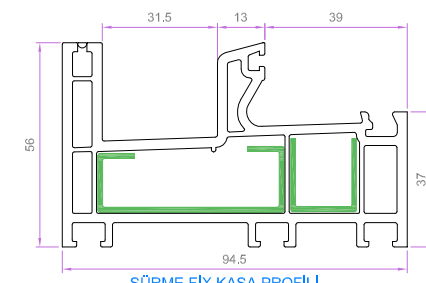

SÜRME FIX KASA PROFİLİ
7403 1.595 kg/m

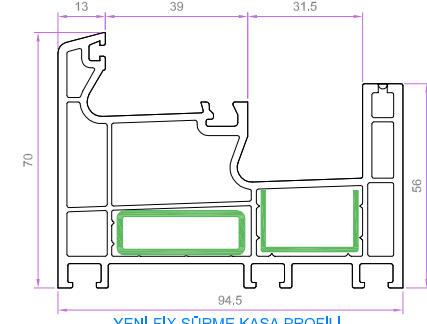

YENİ FIX SÜRME KASA PROFİLİ
7411 1.625 kg/m

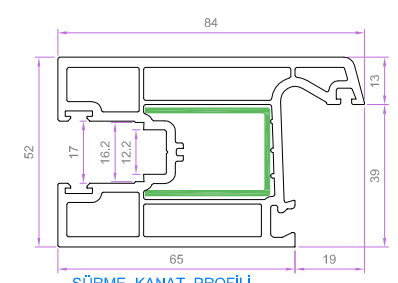

SÜRME KANAT PROFİLİ
7402 1.468 kg/m

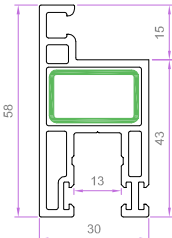

SİNEKLİK SÜRME KANAT
7408 0.644 kg/m

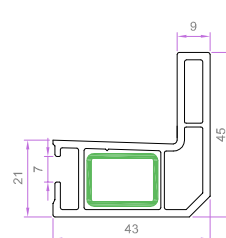

SİNEKLİK RAY KASA
7407 0.520 kg/m

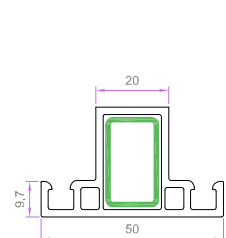

SİNEKLİK KANAT İÇİ KAYIT
7409 0.459 kg/m

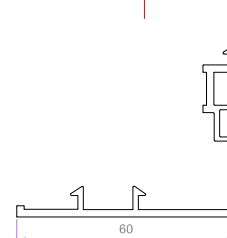

SÜRME INTERLOK PROFİLİ
7404 0.384 kg/m

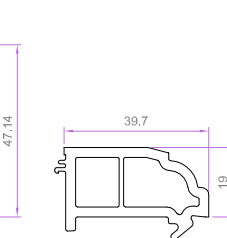

SÜRME FIX KASA KAPAMA
7405 0.468 kg/m

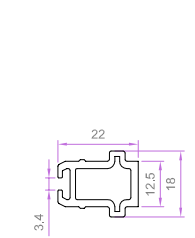

KANAT DOLGU ALIN PR.
7410 0.197 kg/m

7460 COMPACT SÜRME SİSTEM PROFİLLERİ

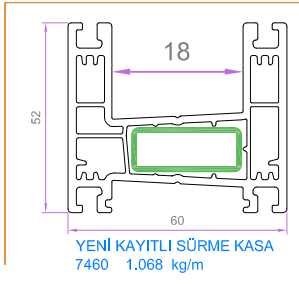

YENİ KAYITLI SÜRME KASA
7460 1.068 kg/m

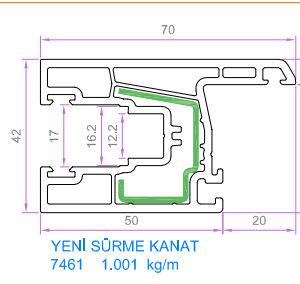

YENİ SÜRME KANAT
7461 1.001 kg/m

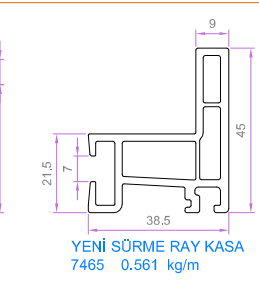

YENİ SÜRME RAY KASA
7465 0.561 kg/m

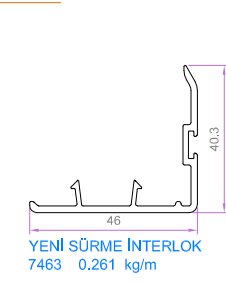

YENİ SÜRME INTERLOK
7463 0.261 kg/m

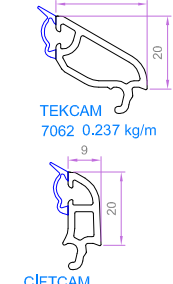

TEKCAM
7062 0.237 kg/m

ÇİFTCAM
7464 0.178 kg/m

ORTAK KULLANILAN YARDIMCI PROFİLLER

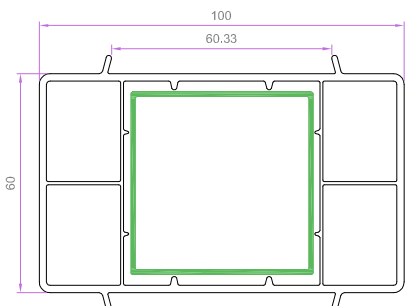

60x100 ODACIKLI KUTU PROFİLİ
6051 1.148 kg/m

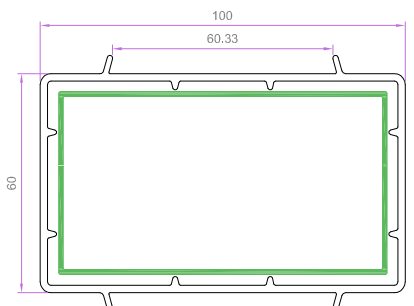

60x100 ODACIKSIZ KUTU PROFİLİ
6052 0.986 kg/m

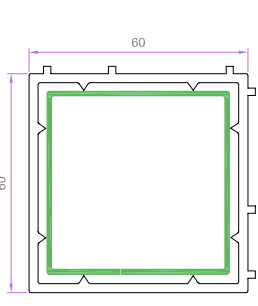

60x60 KUTU PROFİLİ
6020 0.905 kg/m

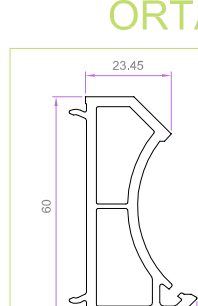

KÖŞE DÖNÜŞ ADAPTÖRÜ
6015 0.678 kg/m

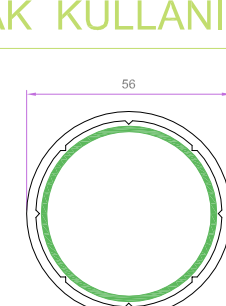

ADAPTÖR BORUSU
6016 0.621 kg/m

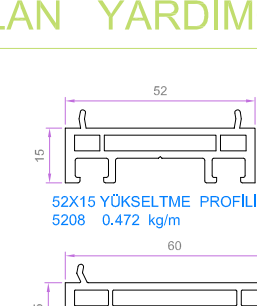

52x15 YÜKSELTME PROFİLİ
5208 0.472 kg/m

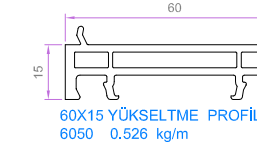

60x15 YÜKSELTME PROFİLİ
6050 0.526 kg/m



DAR BAĞ PROFİLİ
6014 0.265 kg/m

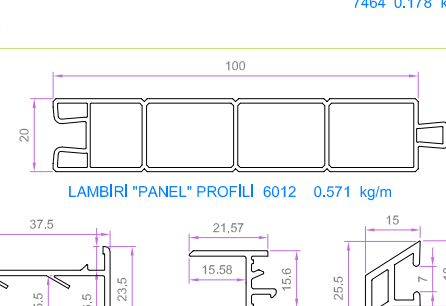

LAMBİRİ "PANEL" PROFİLİ 6012 0.571 kg/m



DENİZLİK ALIN KAPAK
7279 0.110 kg/m

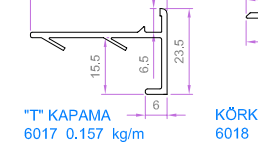

"T" KAPAMA
6017 0.157 kg/m

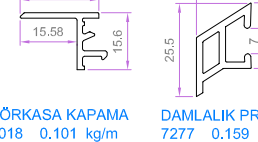

KÖRKASA KAPAMA
6018 0.101 kg/m



DAMLALIK PRF.
7277 0.159 kg/m

ORTAK KULLANILAN YARDIMCI PROFİLLER

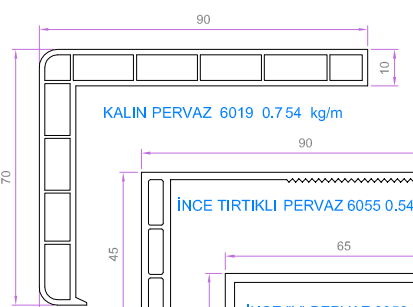

KALIN PERVAZ 6019 0.754 kg/m

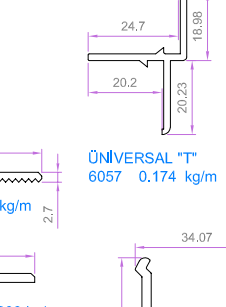

İNCE TIRTIKLI PERVAZ 6055 0.544 kg/m

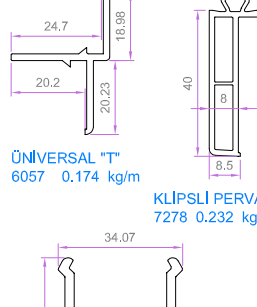

İNCE "L" PERVAZ 6056 0.388 kg/m

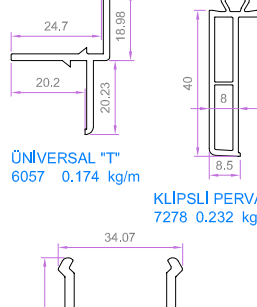

GENİŞ "T" KAPAMA
6021 0.248 kg/m

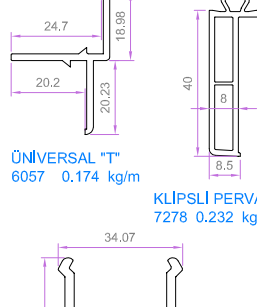

KÖRKASA YÜKSELTME
6053 0.472 kg/m

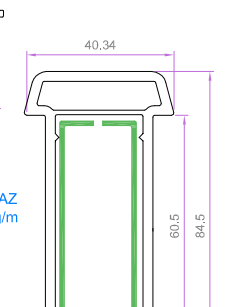

GENİŞ BAĞ (GRİYAJ) PRF.
6013 1.060 kg/m

ALÜMİNYUM YARDIMCI PROFİLLER

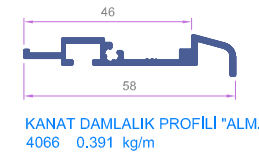

KANAT DAMLALIK PROFİLİ "ALM."
4066 0.391 kg/m

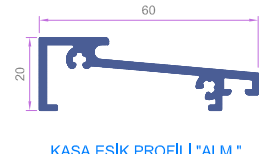

KASA EŞİK PROFİLİ "ALM."
3308 0.668 kg/m



5200 KASA, SÜRME KASA ALM. BAĞ.
1986 0.438 kg/m

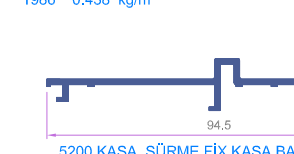

5200 KASA, SÜRME FIX KASA BAĞL. "ALM."
2485 0.560 kg/m

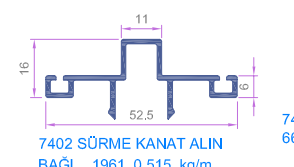

7402 SÜRME KANAT ALIN BAĞL. 1961 0.515 kg/m

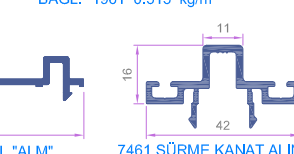

7461 SÜRME KANAT ALIN BAĞL. 6661 0.465 kg/m



7460 RAY
6626 0.075 kg/m



7401-7403-7411 RAY
3065 0.126 kg/m



7406 RAY
4725 0.117 kg/m



5200 SERİ ALM. DAR BAĞ.
2474 0.456 kg/m



O.KAYIT BAĞL. "ALM." 5200
1128 0.874 kg/m

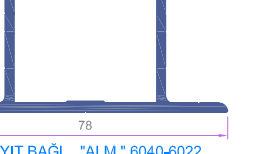

O.KAYIT BAĞL. "ALM." 6040-6022
3101 1.001 kg/m