

ÖLÇÜLENDİRİLMİŞ UYGULAMA DETAYLARI

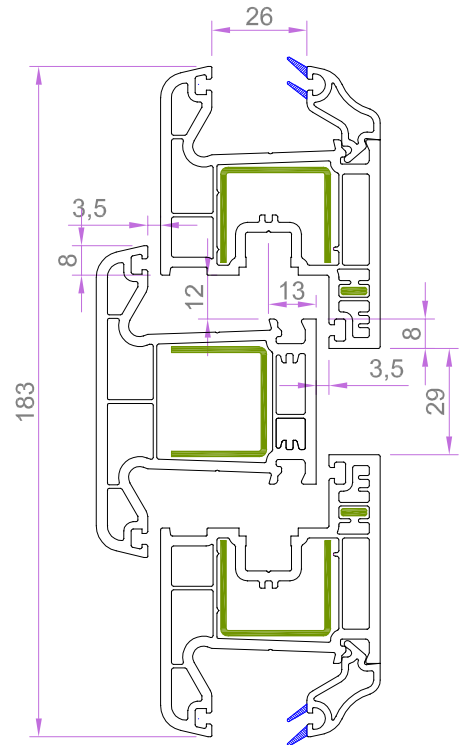

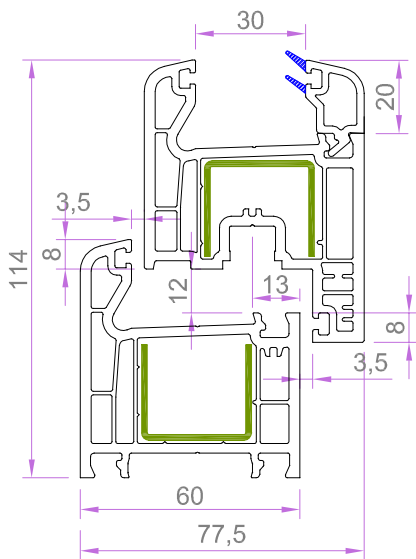

ÖLÇÜLENDİRİLMİŞ ÇİZİMLERİ

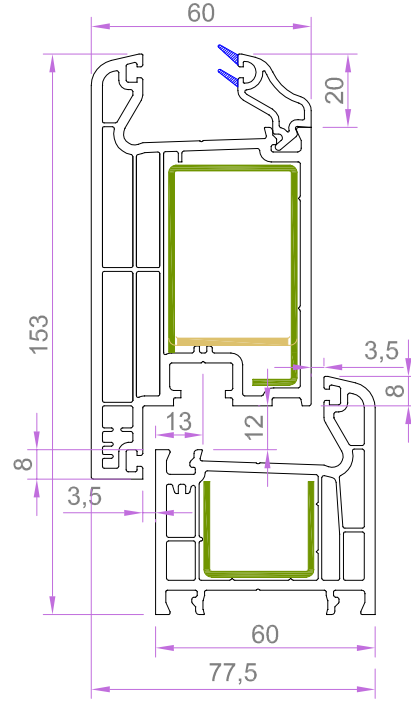
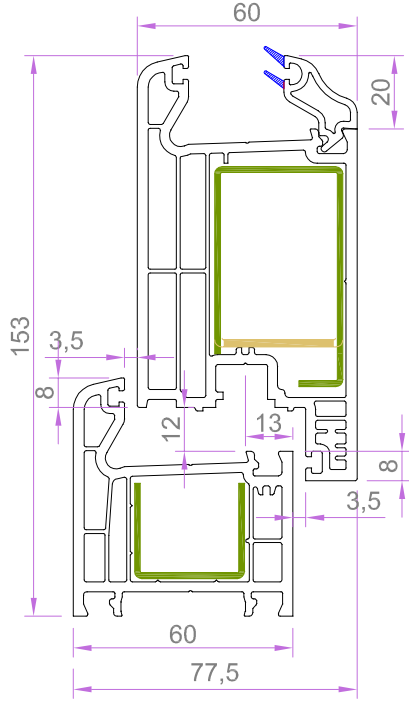
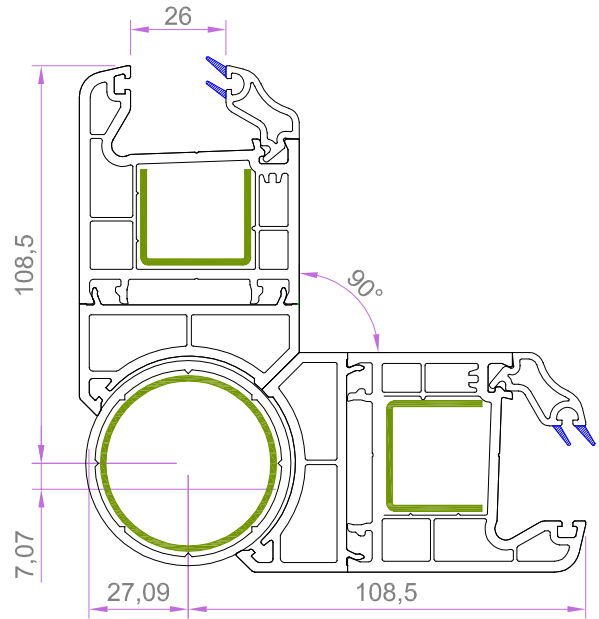
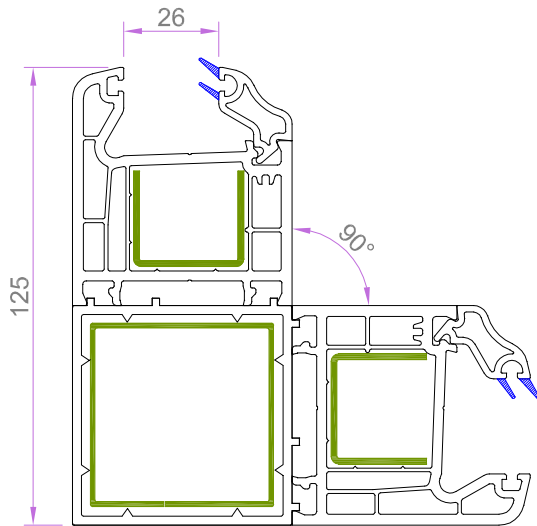
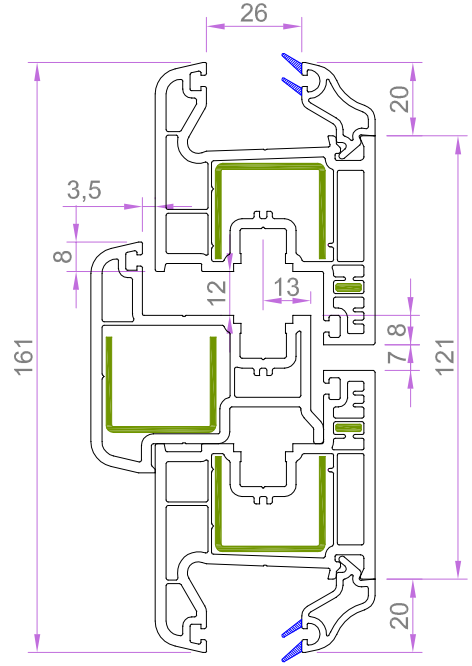
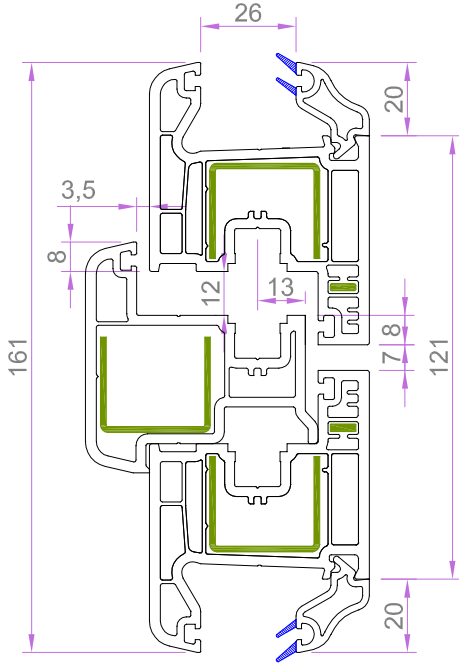
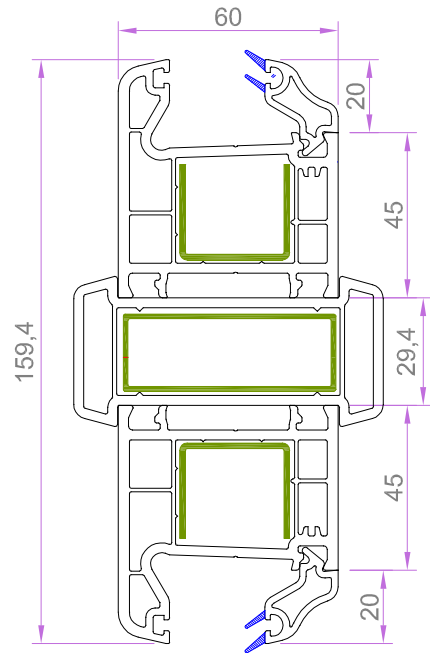
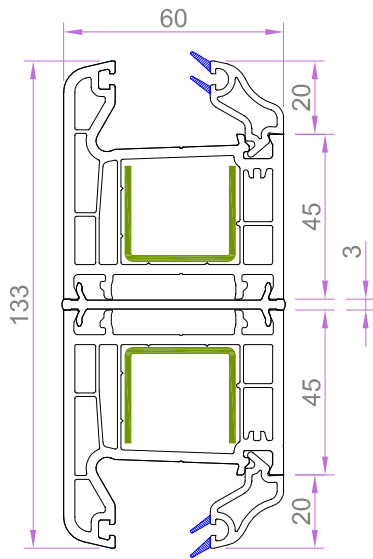
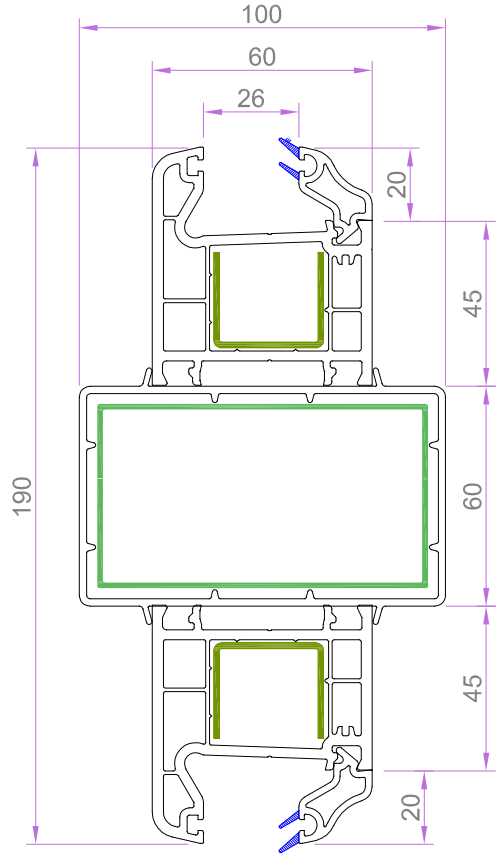
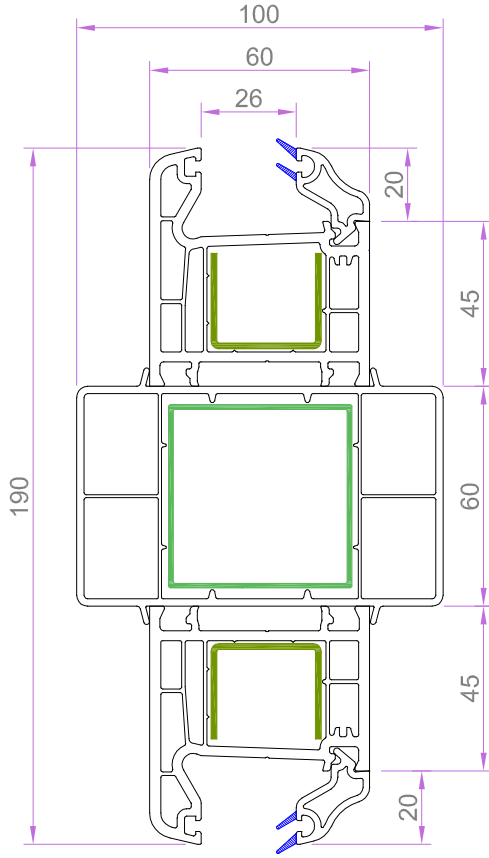

ÖLÇÜLENDİRİLMİŞ ÇİZİMLERİ

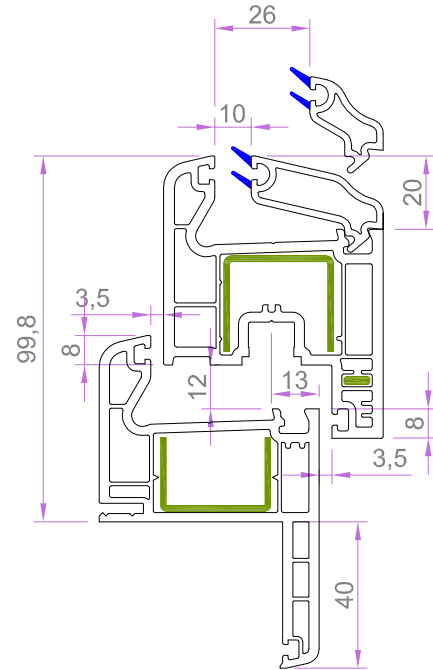
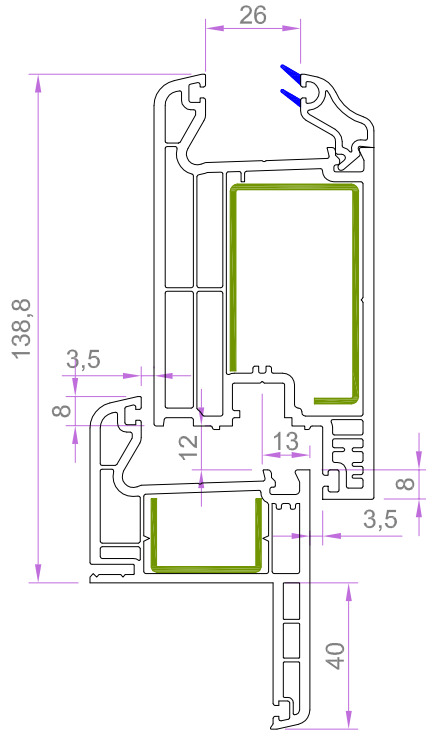
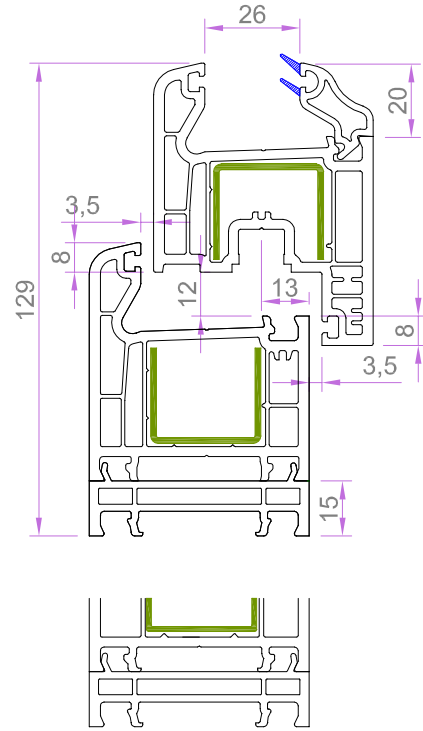
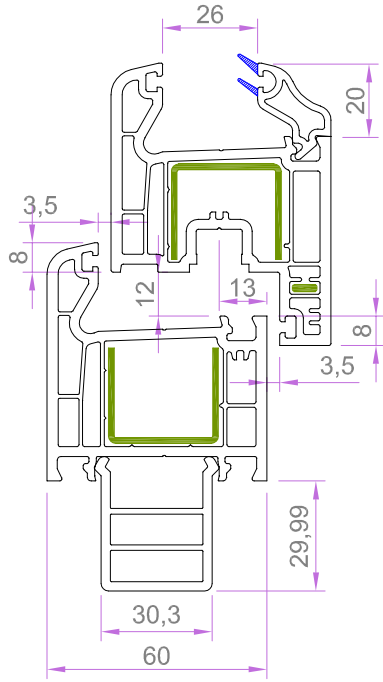

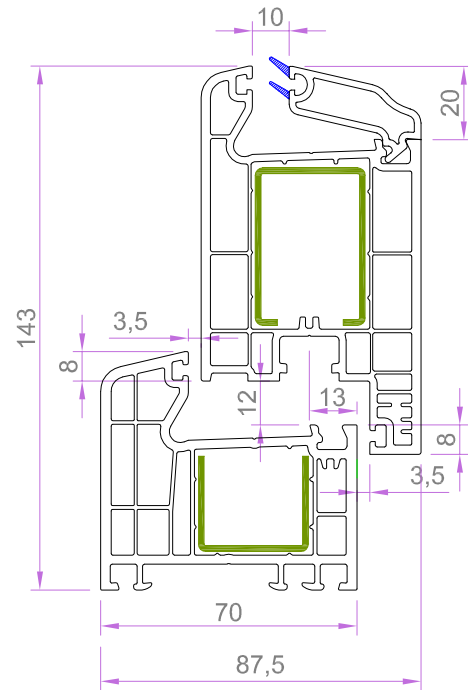
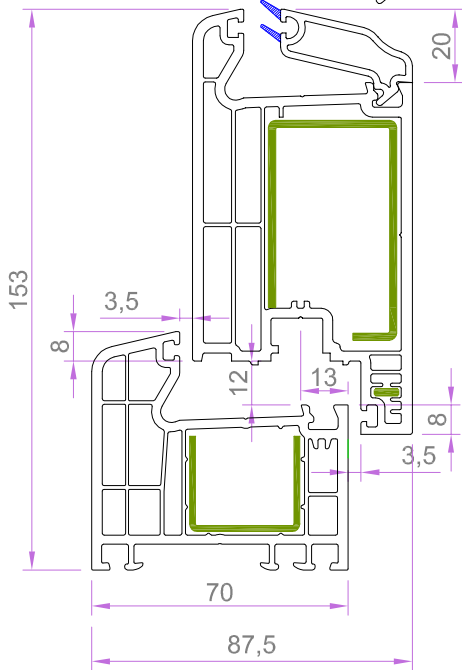
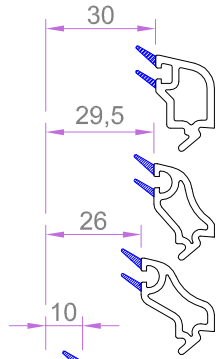
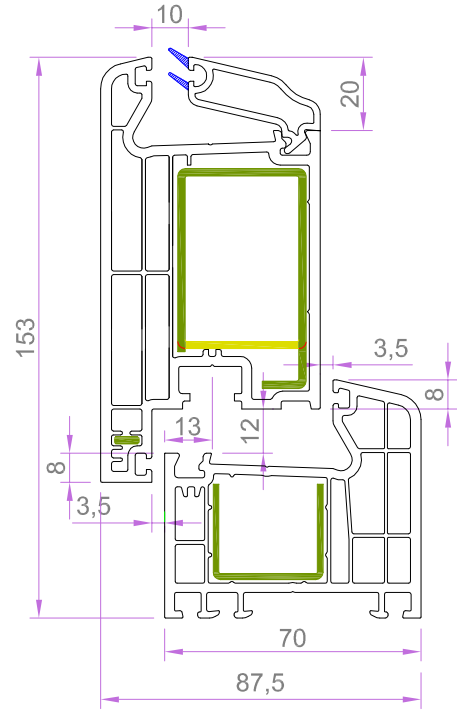
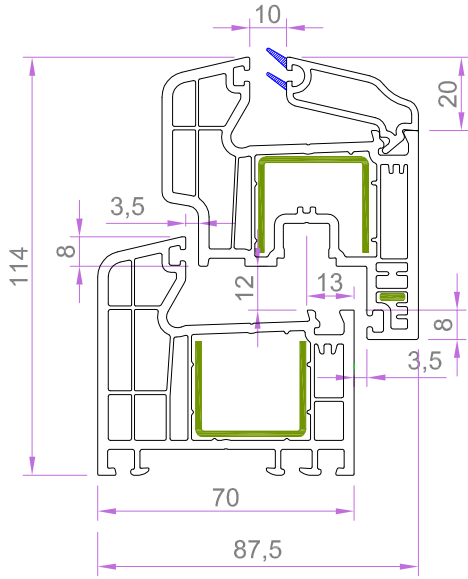

ÖLÇÜLENDİRİLMİŞ ÇİZİMLERİ

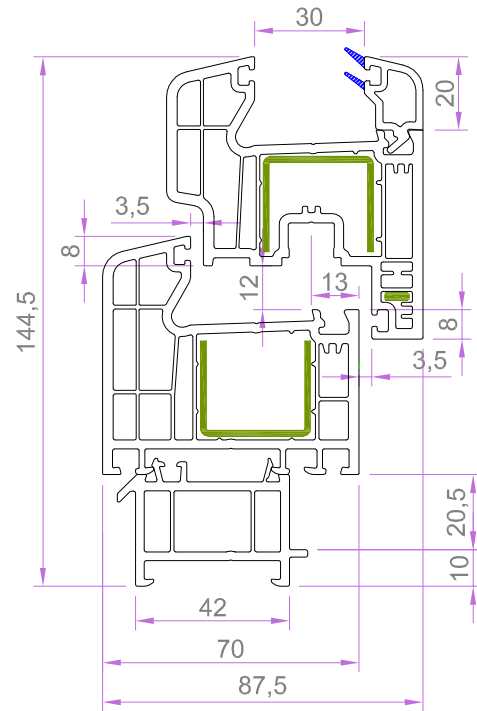
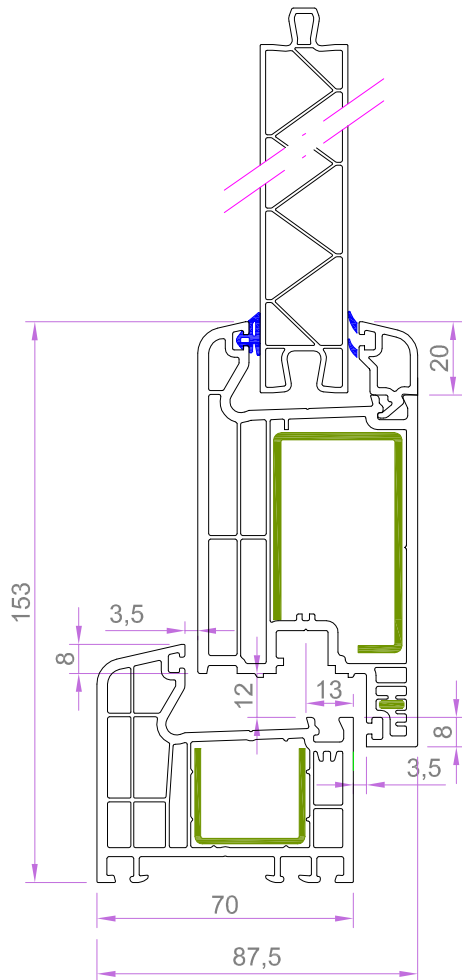
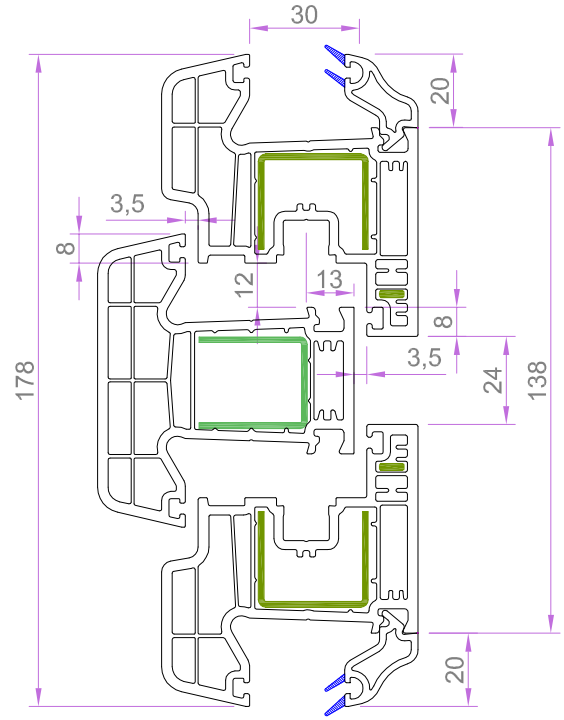
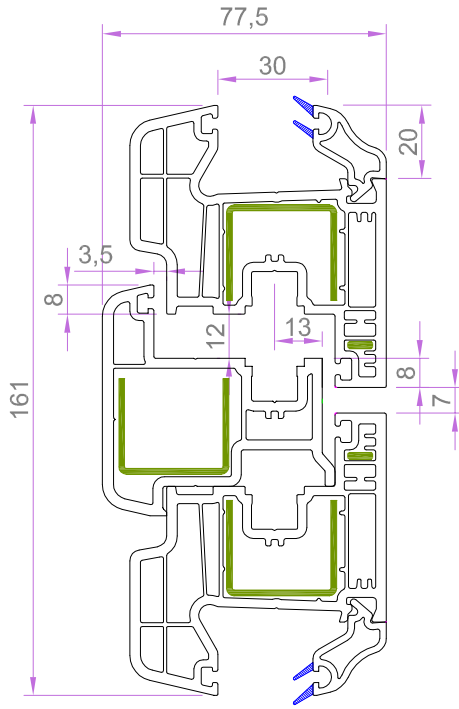

ÖLÇÜLENDİRİLMİŞ ÇİZİMLERİ

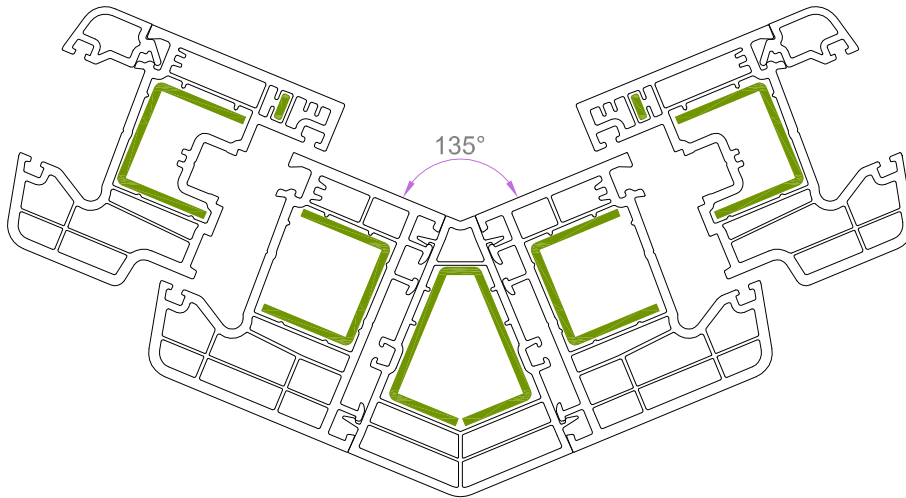
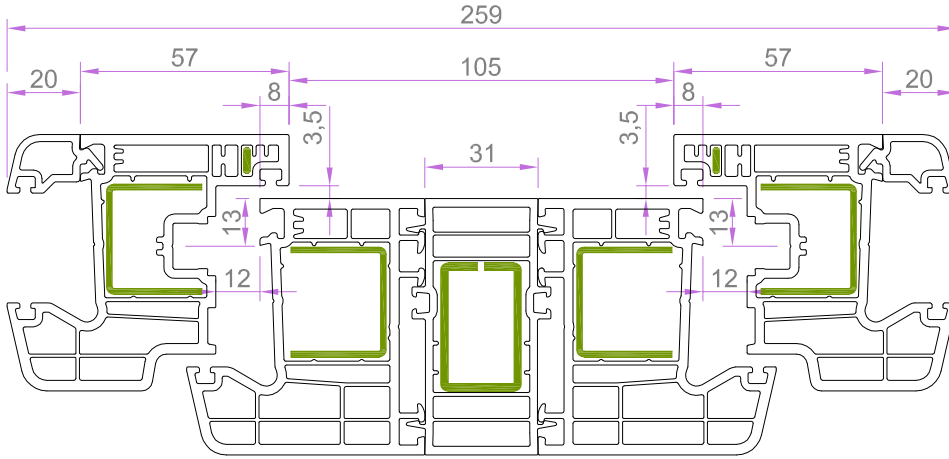
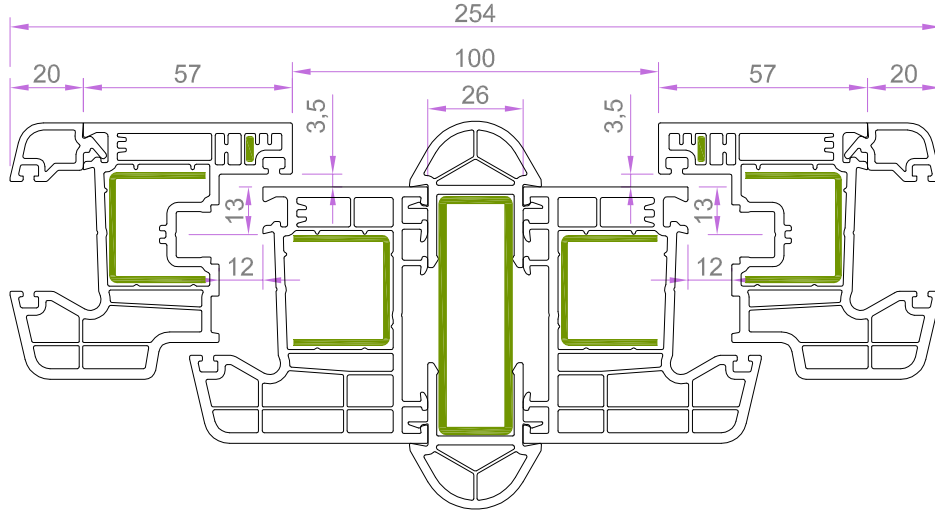

ÖLÇÜLENDİRİLMİŞ ÇİZİMLERİ

