

SCALED APPLICATION DETAILS

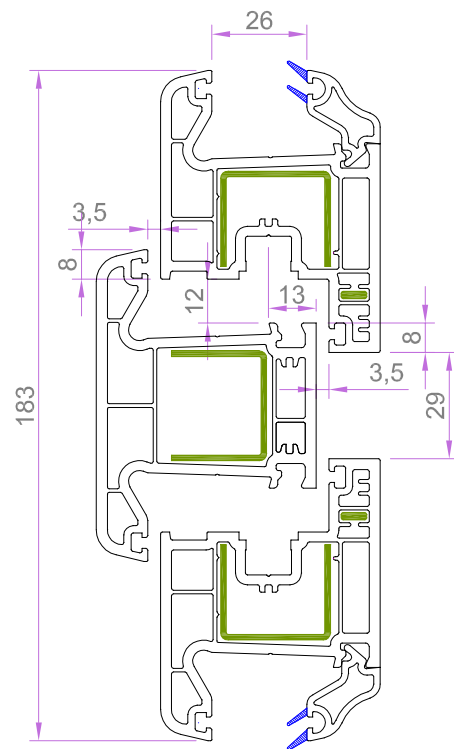

SCALED APPLICATION DETAILS

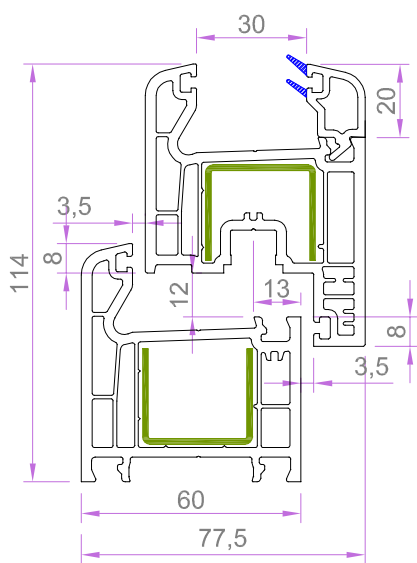
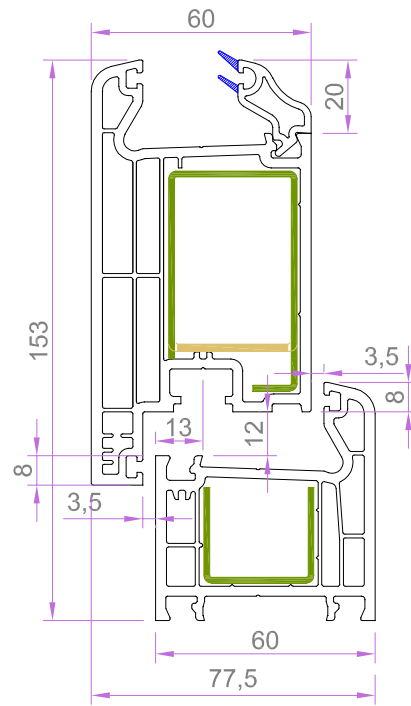
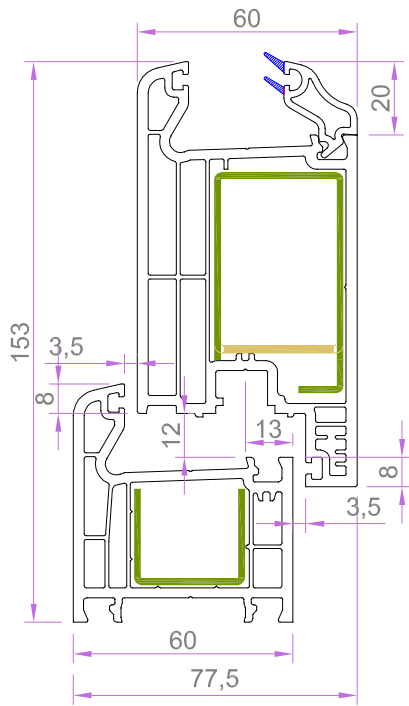
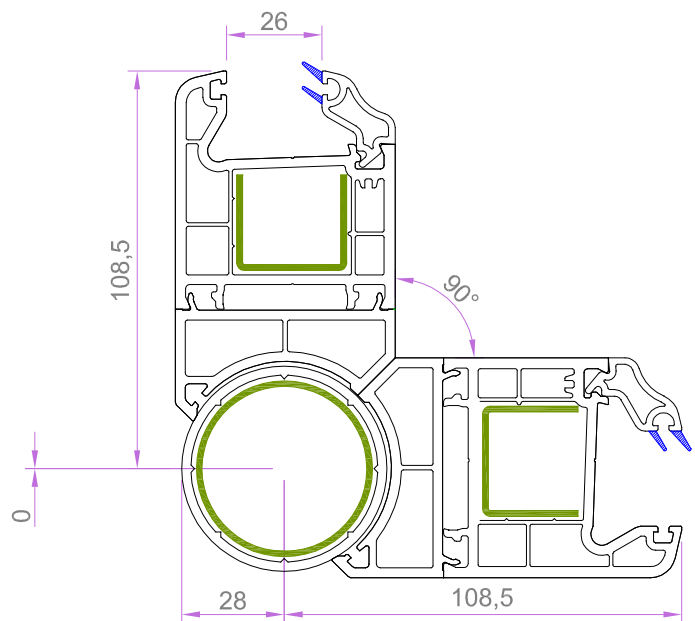
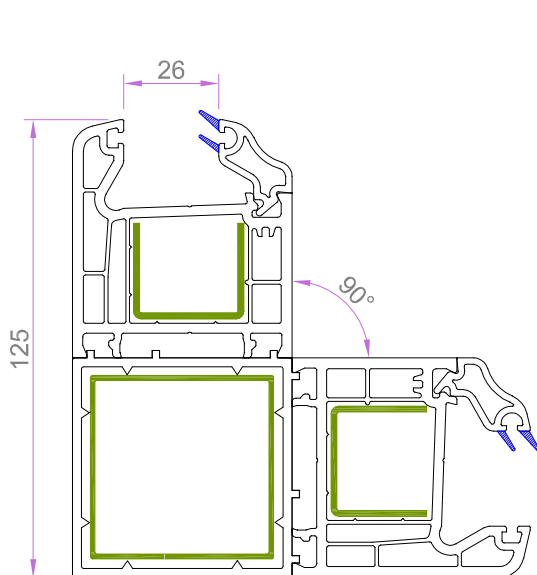
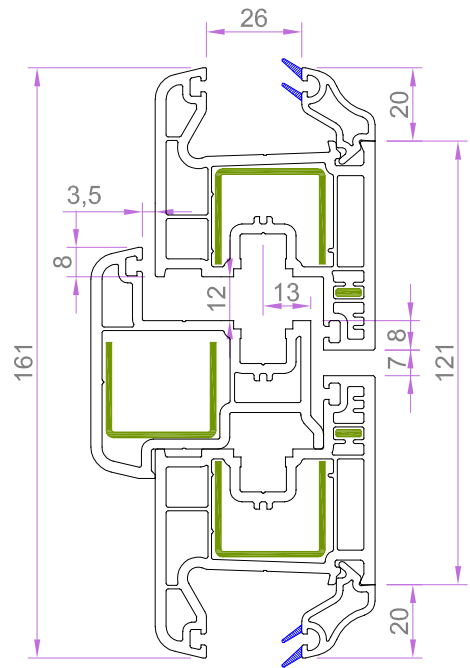
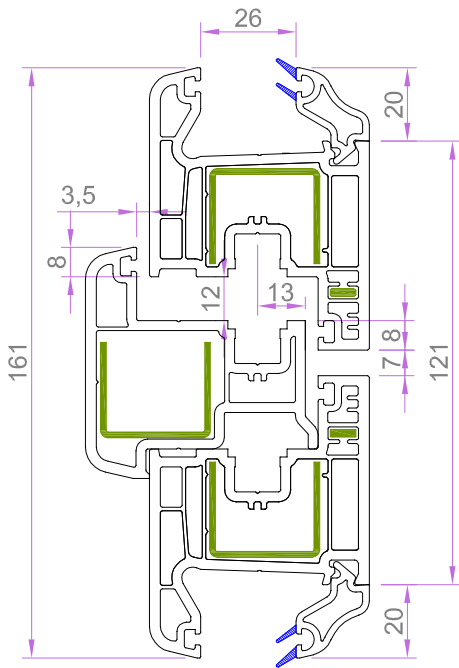

SCALED APPLICATION DETAILS

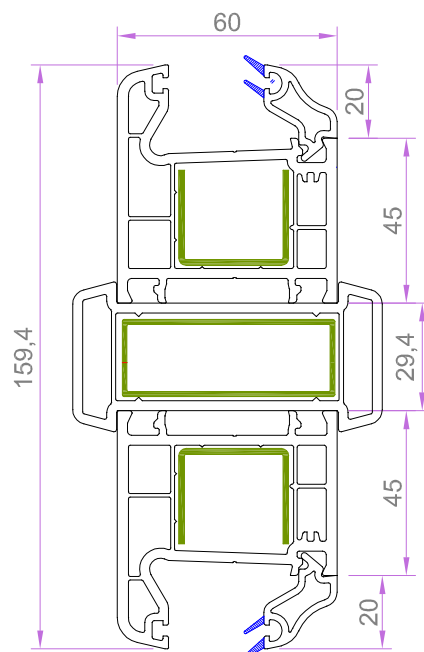
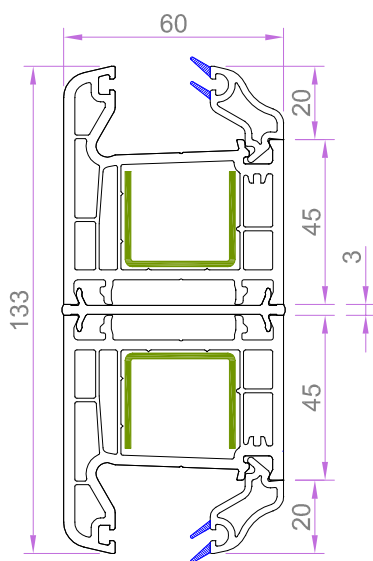
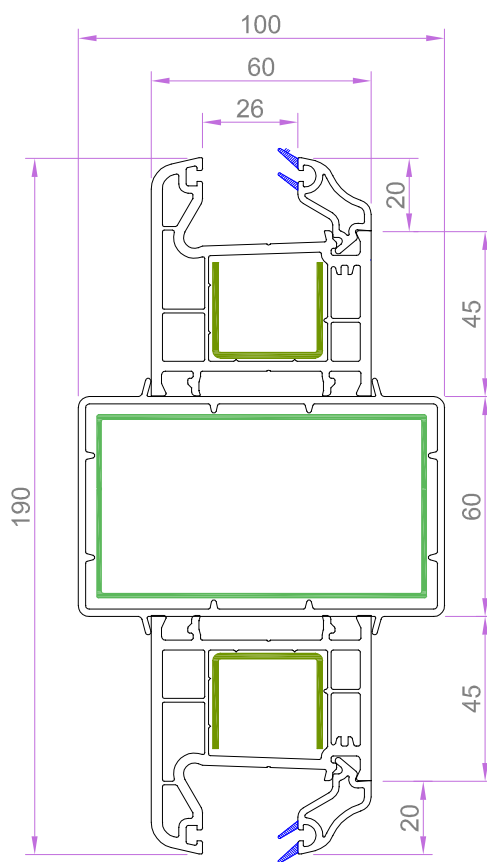
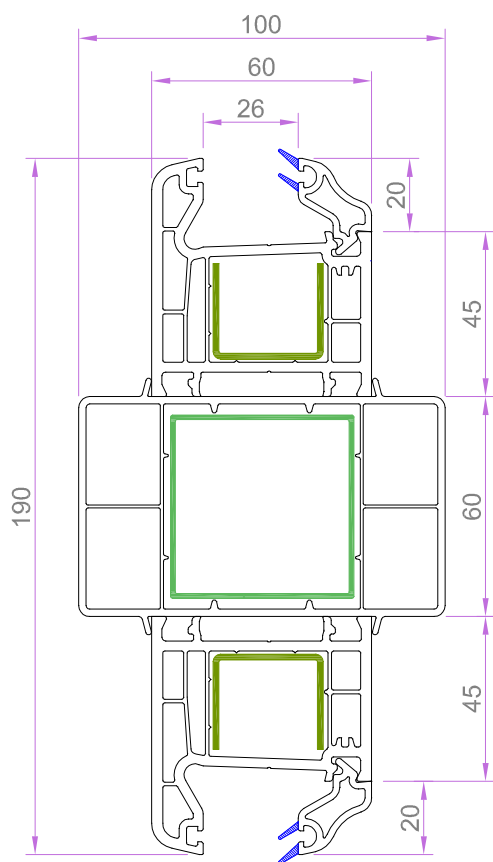

SCALED APPLICATION DETAILS

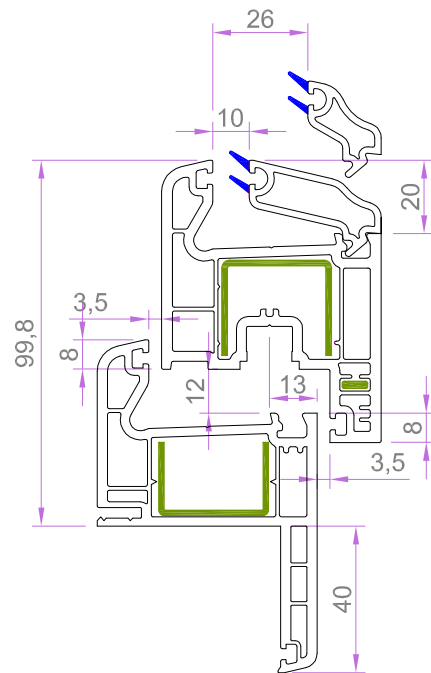
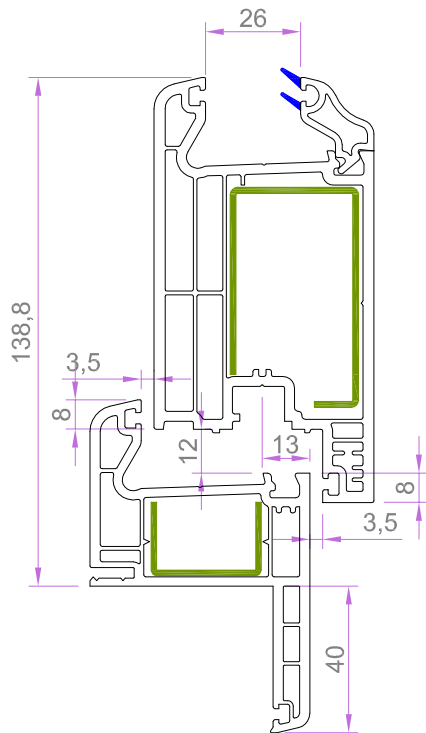
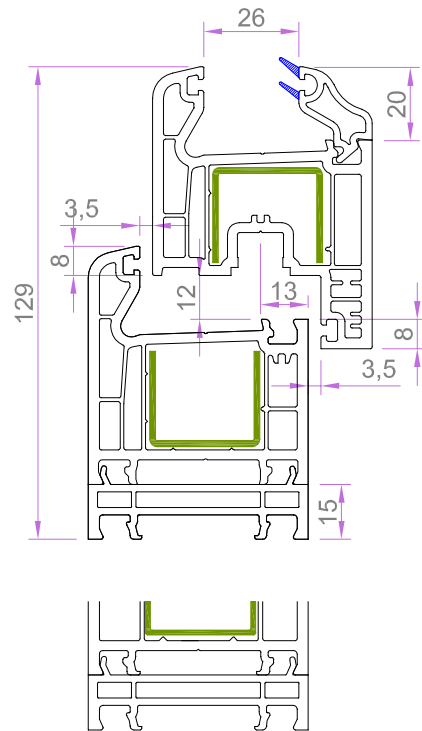
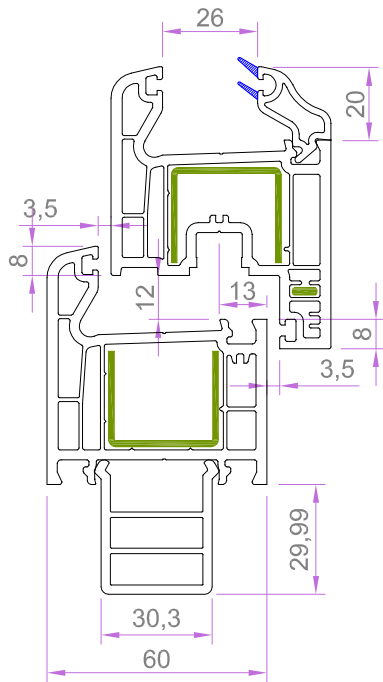

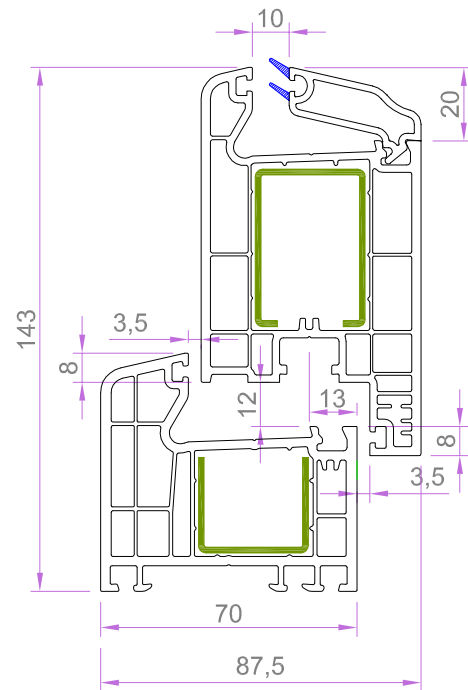
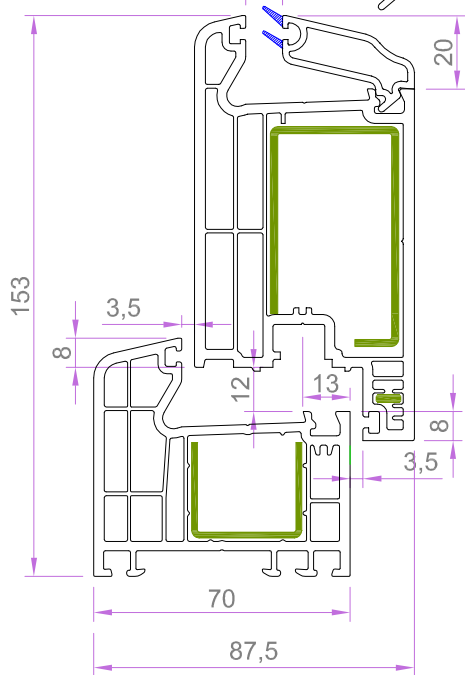
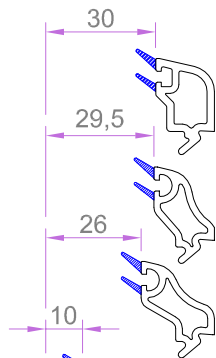
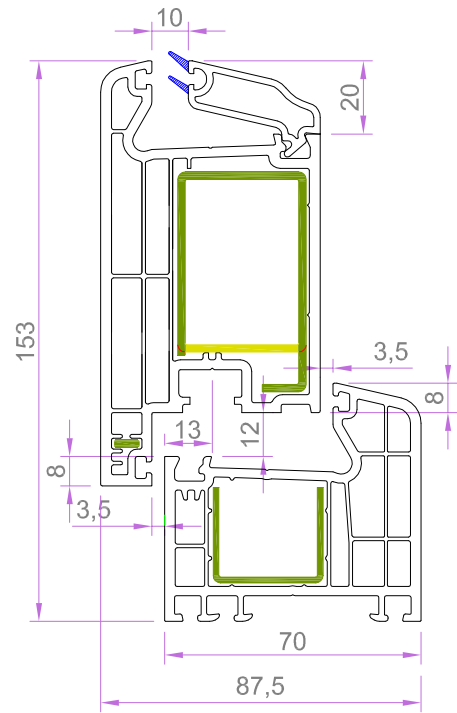
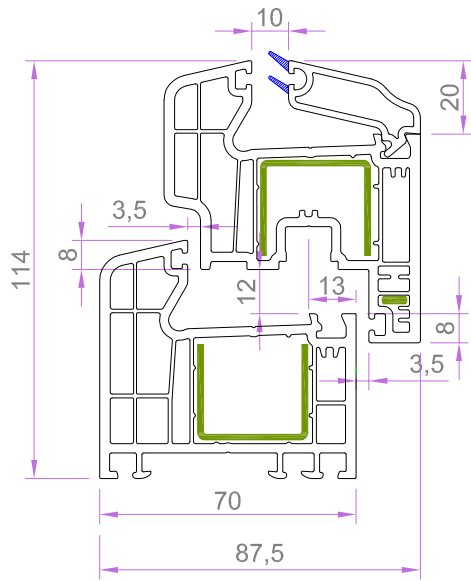

SCALED APPLICATION DETAILS

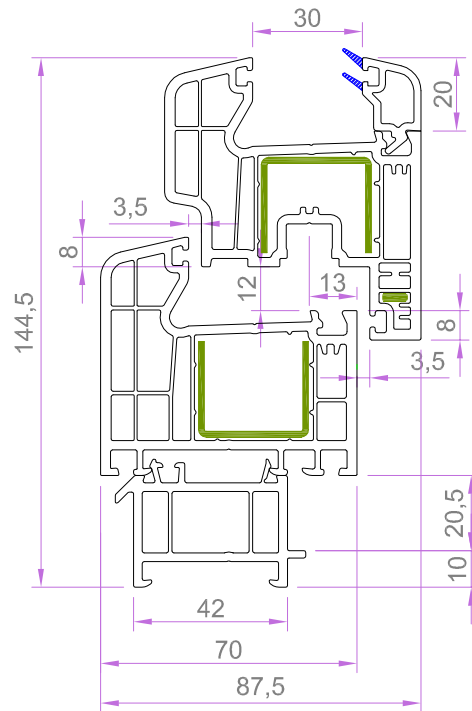
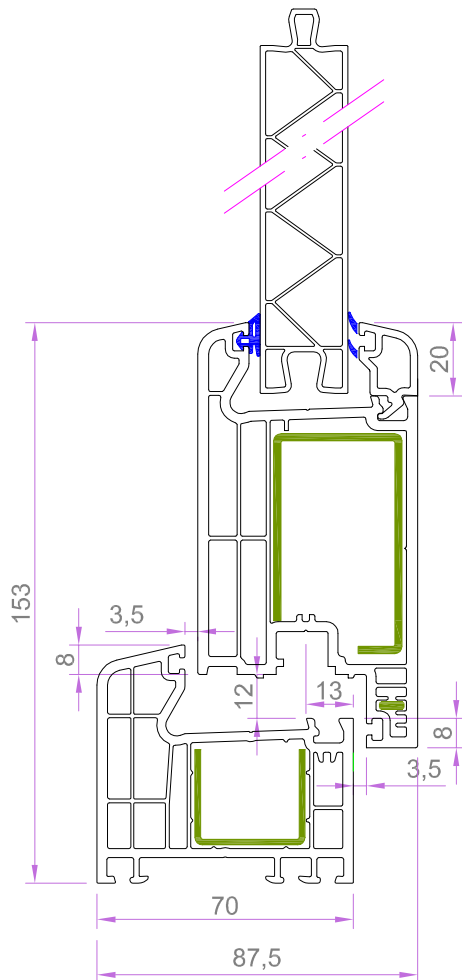
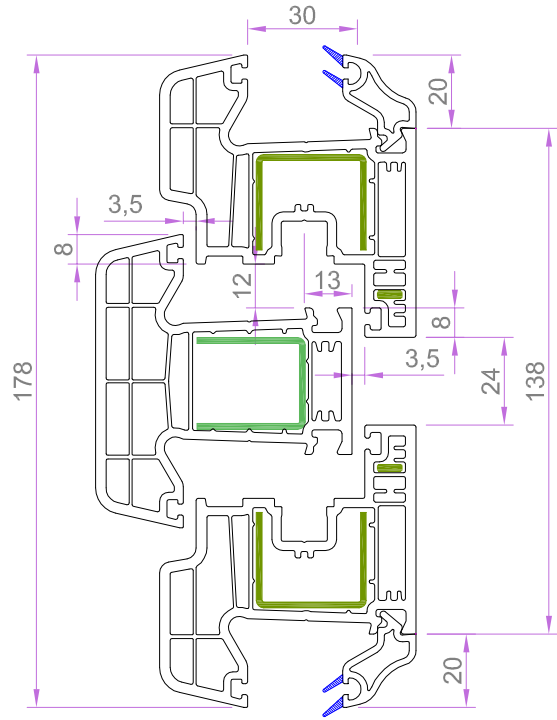
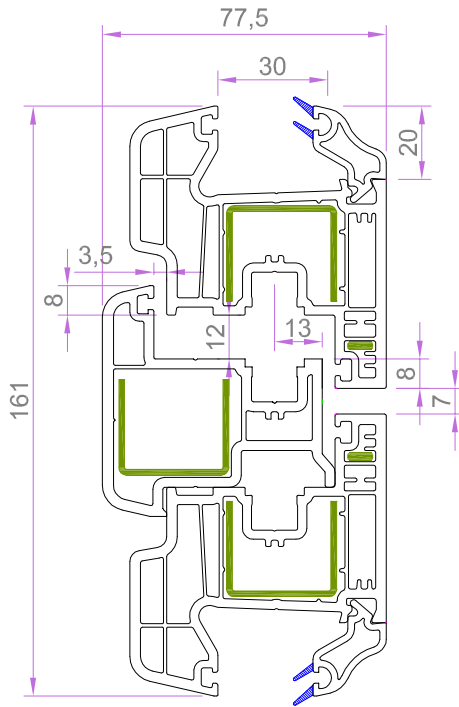

SCALED APPLICATION DETAILS

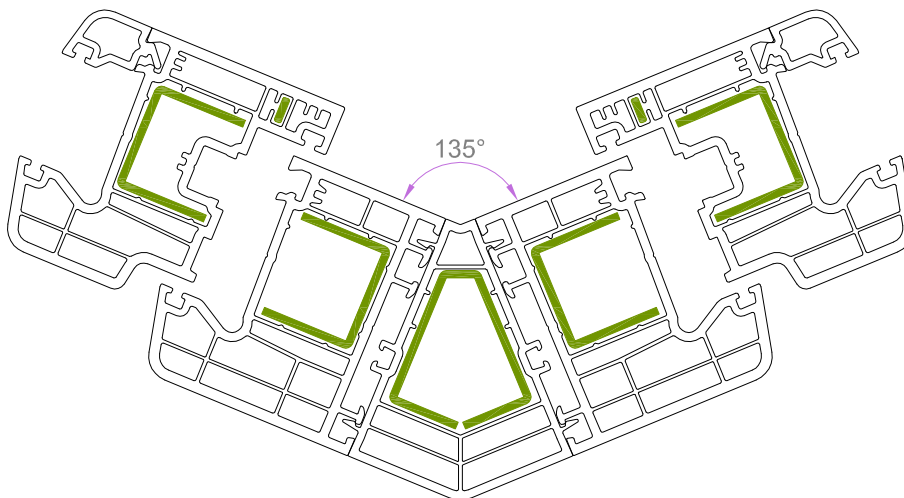
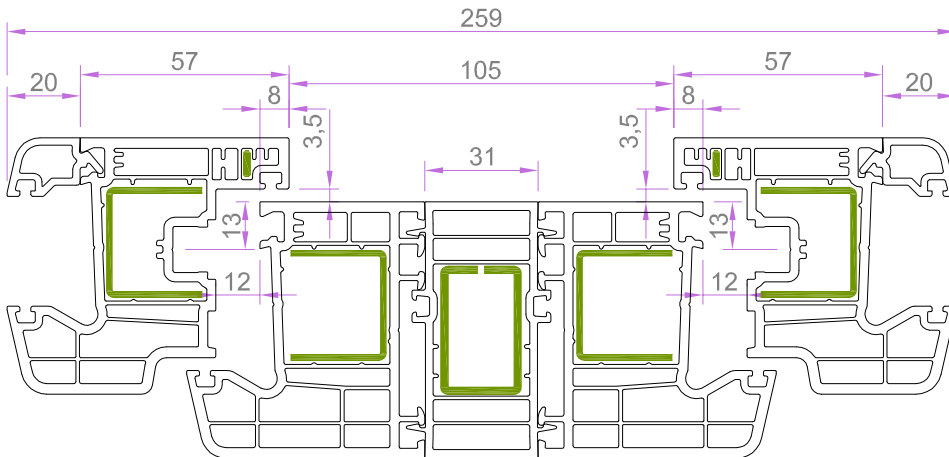
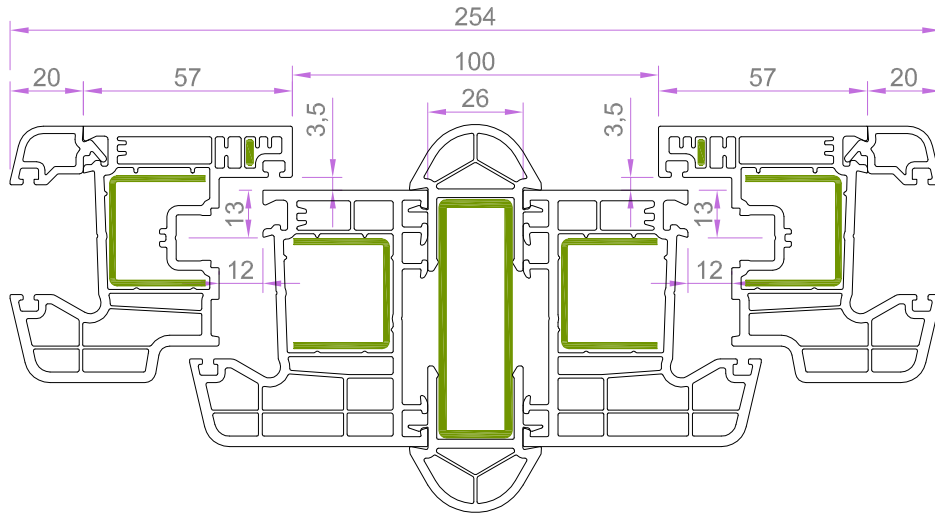

SCALED APPLICATION DETAILS

